

- Specifications:
1. Rated Voltage – 16 VDC
  2. Rated Current – 300 mA
  3. Contact Resistance – 100 mOHMS or less under all conditions, including After Life Testing.
  4. Insulation Resistance – 100 MOHMS or greater at 250 VDC.
  5. Dielectric Withstand Voltage – 250 VAC RMS for 1 minute.

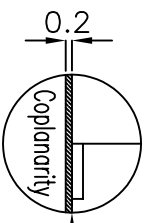
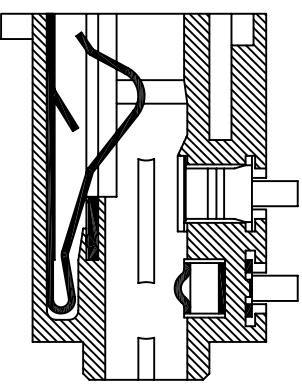
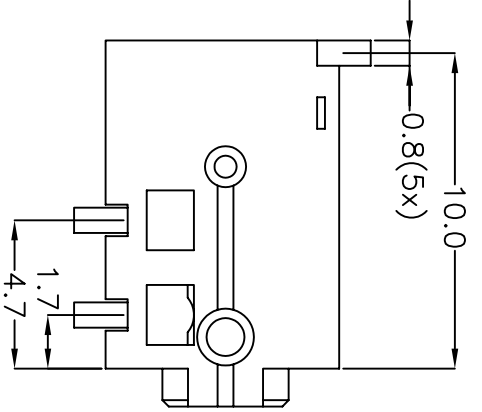
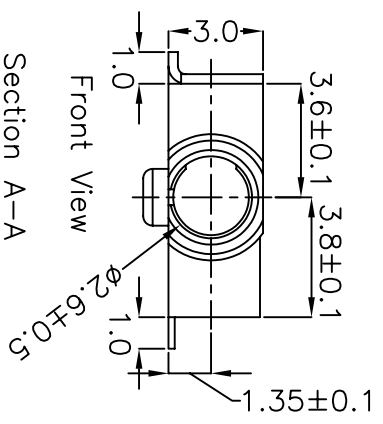
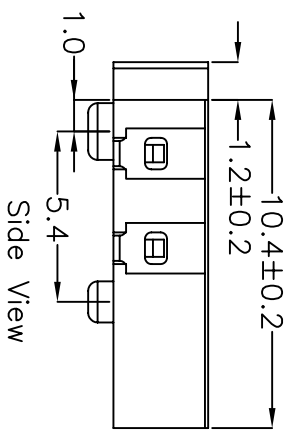
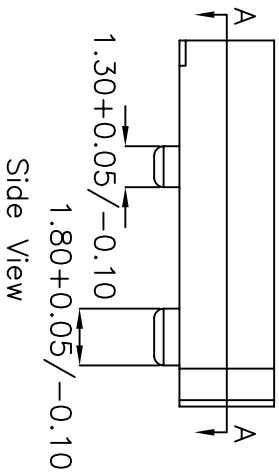
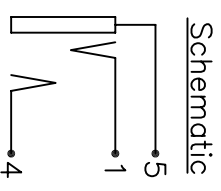

Mounting Surface

Term	Material	Color	Plating	Remark
Plastic Housing <P1>	Polyamide	Black		UL94V-0 Rated
Ring Contact <M1>	Ti-Cu Alloy		Gold Flash	20T
Tip Contact <M4>	Ti-Cu Alloy		Gold Flash	20T
Ground <M5>	Ti-Cu Alloy		Gold Flash	20T

ROHS Compliant



9615 SW Allen, Suite 103  
 Beaverton, OR 97005  
 Phone: (503) 643-4899  
 800-275-4899  
 Fax: (503) 372-1266  
 Website: www.cui.com

TITLE: 2.50 Surface Mount Jack - Stereo

PART NO. SJ-2533-SMT UNITS: Millimeters

DRAWN BY: Todd R. White APPROVED BY: SCALE: 4X